



HEW2PER3 HEW4PER3B

Network WDR 2MP/4MP IR Ball Camera









OPERATIONAL	
VIDEO STANDARD	NTSC/PAL
SCANNING SYSTEM	Progressive
IMAGE SENSOR	HEW2PER3 : 1/2.8" 2 Megapixel progressive scan CMOS HEW4PER3B : 1/3" 4 Megapixel progressive scan CMOS
NUMBER OF PIXELS (H x V)	HEW2PER3 : 1920(H) x1080(V) HEW4PER3B : 2688(H) x1520(V)
MINIMUM ILLUMINATION	HEW2PER3 : 0.06lux/F1.6(color,30IRE) 0Lux/F1.6(IR on) HEW4PER3B : 0.4lux/F1.6(color,30IRE) 0Lux/F1.6(IR on)
S/N RATIO	More than 45dB
ELECTRONIC SHUTTER SPEED	1/3~1/100000s
IR DISTANCE	Up to 50m (164ft), depending on scene reflectance
IR LIGHT CONTROL	Manual/SmartIR/OFF
IR LIGHT NUMBER	1
DAY/NIGHT	Auto(ICR) / Color / B/W
BACKLIGHT COMPENSATION	BLC / HLC / WDR
WHITE BALANCE	Auto/Natural/Street Lamp/Outdoor/Manual/ Customized Region
GAIN CONTROL	0~100
WIDE DYNAMIC RANGE	120dB
NOISE REDUCTION	3D DNR
PRIVACY MASKING	Off / On (4 Areas, Rectangle)
MOTION DETECTION	Off / On (4 Zones, Rectangle)
REGION OF INTEREST	Off / On (4 Zones)
FACE DETECTION	Supported
AUDIO DETECTION	Supported
LENS	2.8mm, Fixed, F1.6
ANGLE OF VIEW	HEW2PER3 : H:110°, V:60° HEW4PER3B : H:104°, V:58°
VIDEO	
VIDEO COMPRESSION	H.265/H.264H/Smart Codec/MJPEG (Sub Stream)
RESOLUTION	HEW2PER3 : 1080P(1920x1080)/1.3M(1280x960)/720P(1280x720)/D1(704x480/576)/CIF(352x240/288) HEW4PER3B : 4M(2688x1520)/3M(2304x1296)/1080P(1920x1080)/1.3M(1280x960)/720P(1280x720)/D1(704x480/576)/CIF(352x240/288)
FRAME RATE	HEW2PER3 : Main Stream: 1080P (1~50/60fps) Sub Stream: D1(1~50/60fps) Third Stream: 1080P(1~25/30fps) HEW4PER3B : Main Stream: 4M(1~25/30fps) Sub Stream: D1(1~25/30fps) Third Stream: 720P(1~25/30fps)

VIDEO (CONT'D)	
BIT RATE CONTROL	CBR/VBR
BIT RATE	H.264: 24~10240Kbps H.265: 14~9984Kbps
AUDIO	
COMPRESSION	G.711a /G.711Mu /AAC /G.726
INTERFACE	Built-in Mic
NETWORK	
ETHERNET	RJ-45 (10/100Base-T)
SUPPORTED WEB BROWSERS	Internet Explorer (11.0+)
SUPPORTED OS	Windows® 7 32-bit/64-bit; Windows® 10 32-bit/64-bit
PROTOCOLS*	HTTP; HTTPS; TCP; ARP; RTSP; RTP; RTCP; UDP; SMTP; DHCP; DNS; PPPoE; IPv4/v6; QoS; UPnP; NTP; Bonjour; IEEE 802.1x; Multicast; ICMP; IGMP; TLS
INTEROPERABILITY	ONVIF Profile S/G/Q
MAXIMUM USERS ACCESS	20 Users
SECURITY	User account and password protection HTTPS, IP Filter, Digest authentication, User access log, TLS1.2 only, AES-128/256, SSH/Telnet closed, sFTP by default, PCIDSS compliance
EVENT	No SD card, SD card error, Capacity warning, Network disconnection, IP conflict, Illegal access
MICRO SD	Up to 128 GB microSDHC card, Class 10 (not included)
ELECTRICAL	
POWER SUPPLY	DC12V, PoE (IEEE802.3af) (Class 0)
POWER CONSUMPTION	<5.5W
MECHANICAL	
DIMENSIONS	Ø106mmx93.7mm (4.17"x3.69")
PRODUCT WEIGHT	0.46kg (1.01lb)
PACKAGE WEIGHT	0.65Kg (1.43lb)
CONSTRUCTION	Die-cast aluminum housing with powder coat
CONSTRUCTION COLOR	HEW2PER3 : RAL 9003 (White) HEW4PER3B : RAL 7022 (Grey)
ENVIRONMENTAL	
OPERATING TEMPERATURE	-30° C ~ +60° C (-22° F ~ +140° F)
RELATIVE HUMIDITY	Less than 95%, non-condensing
INGRESS PROTECTION	IP66
REGULATORY	
EMISSIONS	FCC Part 15B, EN55032
IMMUNITY	EN 50130-4
SAFETY	UL 60950-1, EN 62368-1
ROHS	EN 50581

* Some development may be required in specific user cases to support some of these protocols in the field as they mature over time.

Network WDR 2MP/4MP IR Ball Camera

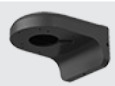
RECOMMENDED ACCESSORIES

SYSTEM COMPATIBILITY		MOUNTS AND ACCESSORIES	
HEN*4	8/16/32/64-channel Performance Series 4K NVRs (H.264 and H.265)	HQA-BB3G**	 Junction Box (grey)
HEN*3	4/8/16/32-channel Performance Series 4K NVRs (H.264 and H.265)	HQA-PM2**	 Pole Mount Adapter (white)
HEN*2	4/8/16-channel Performance Series NVRs (H.264)	HQA-PM2B**	 Pole Mount Adapter (grey)
HRHT4*	4/8/16-channel 4 MP HQA/IP/CVBS Hybrid DVRs (H.264)	HQA-PK**	 Pendant Mount Cap
MOUNTS AND ACCESSORIES		HQA-CBE**	 Ceiling Mount Extend Bracket for HQA-CB
HQA-WK2	 Outdoor Wall Mount Bracket (white)	HQA-CB**	 Ceiling Mount Bracket for Pendant Mount Cap
HQA-WK2G	 Outdoor Wall Mount Bracket (grey)		
HQA-BB3**	 Junction Box (white)		

** The HQA-BB3/HQA-BB3G must be used when installing the camera to HQA-PM2 or HQA-PM2B, vice versa.

The HQA-PK must be used when installing the camera to HQA-CB.

The HQA-CBE must be used with HQA-CB together.

ORDERING

HEW2PER3	Network WDR 2MP IR Ball Camera, 1/2.8" CMOS, 2.8mm Fixed, 1 IR LED, PoE, IP66, H.265/H.264/Smart Codec, White
HEW4PER3B	Network WDR 4MP IR Ball Camera, 1/3" CMOS, 2.8mm Fixed, 1 IR LED, PoE, IP66, H.265/H.264/Smart Codec, Grey

DIMENSIONS

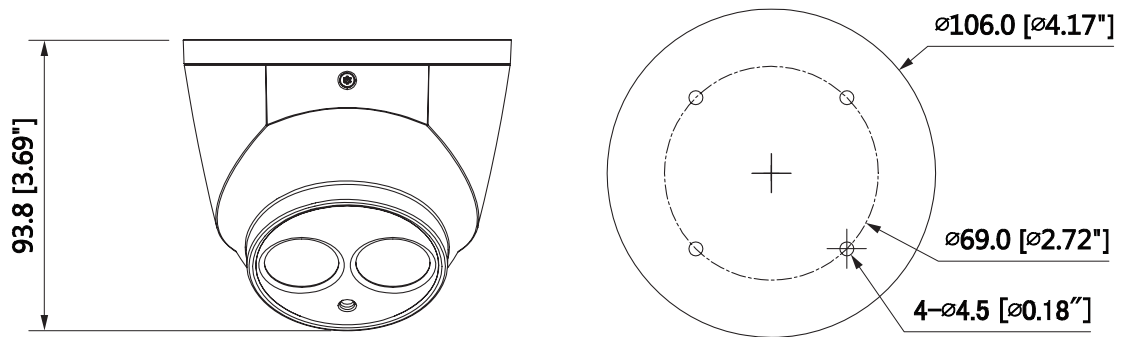

For more information

www.honeywellvideo.com

Honeywell Security

22700 Blankenbaker Pkwy, Suite 150

Louisville, KY 40299

1.800.323.4576

www.honeywell.com

ONVIF and the ONVIF logo are trademarks of ONVIF Inc. Honeywell reserves the right, without notification, to make changes in product design or specifications.

HSV-HEWxPER3x-01-US(1118)DS-Y
© 2018 Honeywell International Inc.

Honeywell